

## Table Of Contents

### Pulls, Plates and Trim

<b>Pulls</b>	page
8102HD Door Pull.....	B2
8103HD Door Pull.....	B2
8103EZHD Door Pull.....	B3
8105 Door Pull.....	B3
8111-5 Door Pull.....	B4
8112-5 Door Pull.....	B4
8121 Door Pull.....	B5
8190HD Offset Door Pull.....	B5

### Push and Pull Plates

8200 Push Plate.....	B6
8300 Pull Plate (less pull).....	B6
8302 Pull Plate.....	B7
8303 Pull Plate.....	B7
8305 Pull Plate (with 8105).....	B7
8311 Pull Plate (with 8111-5).....	B8

### Push Bars

9100HD Pushbar.....	B8
9103EZHD Pushbar & Pull.....	B9
9190HD Pushbar & Pull.....	B9

### Long Door Pulls

9264, 9266.....	B10
-----------------	-----

### Vandal Resistant Trim

VR810-DT, VR814DT Vandal Resistant Trim.....	B11
VR810-NL, VR814-NL Vandal Resistant Trim.....	B11
VR900, VR904 Vandal Resistant Trim.....	B12
VR900LLP, VR904LLP Vandal Resistant Trim.....	B12
VR910-DT, VR914-DT Vandal Resistant Trim.....	B13
VR910-NL, VR914-NL Vandal Resistant Trim.....	B13
VR910M-DT, VR914M-DT Vandal Resistant trim.....	B13
VR910M-NL, VR914M-NL Vandal Resistant Trim.....	B13

### Protection Plates

8400 Protection Plate.....	B13-14, 18
8402 Protection Plate (UL).....	B13-14, 18

### Mounting Detail

Special Mounting Detail.....	B15-17
------------------------------	--------



A  
Hinges & Pivots

B1  
Pulls & Plates

C  
Flush Bolts & Coordinators

D  
Latches, Catches & Bolts

E  
Stops

F  
Exterior Hardware

G  
Miscellaneous Hardware

**A**  
Hinges & Pivots

**B2**  
Pulls & Plates

**C**  
Flush Bolts & Coordinators

**D**  
Latches, Catches & Bolts

**E**  
Stops

**F**  
Exterior Hardware

**G**  
Miscellaneous Hardware

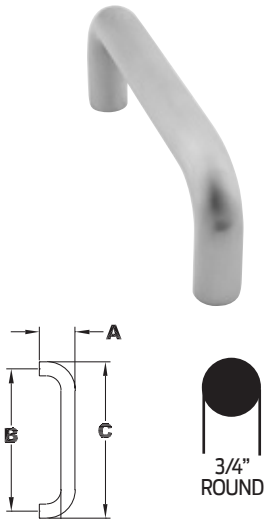

### 8102HD Door Pull - 3/4" Round

Available mounting – standard, F, H-I-L, or J see pages B15 and B16  
– 5/16-18" mounting screw size

#### Available Sizes

6", 8", 10"

Product No.	Projection "A"	Clearance	Center to Center "B"	Overall Length "C"
8102-6	2-1/4"	1-1/2"	6"	6-3/4"
8102-8	2-1/4"	1-1/2"	8"	8-3/4"
8102-0	2-1/4"	1-1/2"	10"	10-3/4"

#### Finishes brass

US Number	US3	US4	US10	US10B	US15	US26	US26D*
BHMA	605	606	612	613	619	625	626

#### Finishes stainless steel

US Number	US32D*
BHMA	630

#### Finishes aluminum

US Number	US28
BHMA	628

\* Available with Antimicrobial Coating, use suffix AM



### 8103HD Door Pull - 1" Round

Available mounting – standard, F, H-I-L, or J see pages B15 and B16  
– 3/8-16" mounting screw

#### Available Sizes

8", 10", 12"

Product No.	Projection "A"	Clearance	Center to Center "B"	Overall Length "C"
8103-8	2-1/2"	1-1/2"	8"	9"
8103-0	2-1/2"	1-1/2"	10"	11"
8103-2	2-1/2"	1-1/2"	12"	13"

#### Finishes brass

US Number	US3	US4	US10	US10B	US15	US26	US26D*
BHMA	605	606	612	613	619	625	626

#### Finishes stainless steel

US Number	US32	US32D*
BHMA	629	630

#### Finishes aluminum

US Number	US28
BHMA	628

\* Available with Antimicrobial Coating, use suffix AM

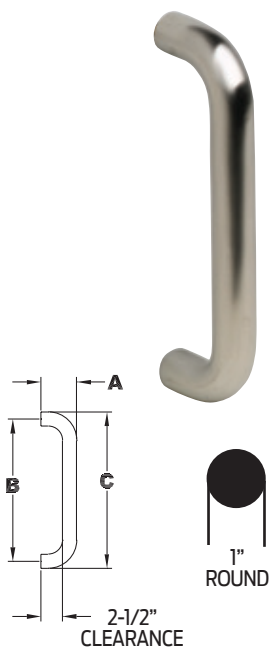

## 8103EZHD Door Pull - 1" Round Large 2-1/2" Clearance for the Accessibility Applications

Available mounting – standard, O, H-I-L, J see pages B15 and B17  
with Heavy Duty 3/8-16" mounting screws

### Available Sizes

8", 10", 12"

Product No.	Projection "A"	Clearance	Center to Center "B"	Overall Length "C"
8103EZ	3-1/2"	2-1/2"	8"	9"
8103EZ	3-1/2"	2-1/2"	10"	11"
8103EZ	3-1/2"	2-1/2"	12"	13"

### Finishes brass

US Number	US3	US4	US10	US10B	US15	US26	US26D*
BHMA	605	606	612	613	619	625	626

### Finishes stainless steel

US Number	US32	US32D*
BHMA	629	630

### Finishes aluminum

US Number	US28
BHMA	628

\* Available with Antimicrobial Coating, use suffix AM

## 8105 Door Pull - 1" Flattened

Available mounting – standard or F see page B15  
– 1/4 - 20" mounting screws

### Available Sizes

6", 8", 10"

Product No.	Projection "A"	Center to Center "B"	Overall Length "C"
8105-6	2"	6"	6-1/2"
8105-8	2"	8"	8-1/2"
8105-0	2"	10"	10-1/2"

### Finishes brass

US Number	US3	US4	US10	US10B	US15	US26	US26D*
BHMA	605	606	612	613	619	625	626

### Finishes stainless steel

US Number	US32D*
BHMA	630

### Finishes aluminum

US Number	US28
BHMA	628

\* Available with Antimicrobial Coating, use suffix AM

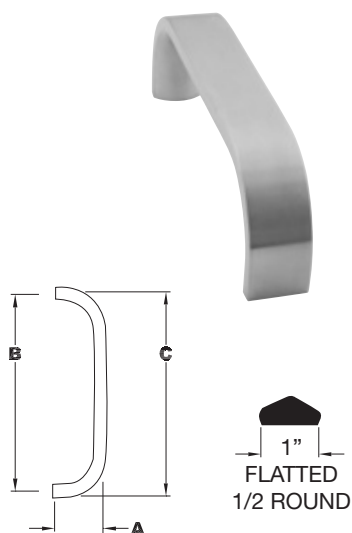

A  
Hinges & Pivots

B3  
Pulls & Plates

C  
Flush Bolts & Coordinators

D  
Latches, Catches & Bolts

E  
Stops

F  
Exterior Hardware

G  
Miscellaneous Hardware

**A**  
Hinges & Pivots

**B4**  
Pulls & Plates

**C**  
Flush Bolts & Coordinators

**D**  
Latches, Catches & Bolts

**E**  
Stops

**F**  
Exterior Hardware

**G**  
Miscellaneous Hardware

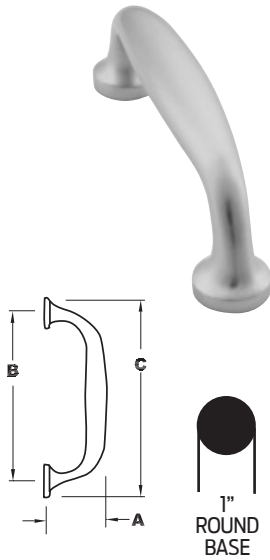

### 8111-5 Door Pull

Available mounting – 1/4-20" mounting screws, standard see page B15

#### Size

5-1/4"

Product No.	Projection "A"	Center to Center "B"	Overall Length "C"
8111-5	1-13/16"	5-1/4"	6-1/4"

#### Finishes *brass*

US Number	US3	US4	US10	US10B	US15	US26	US26D*
BHMA	605	606	612	613	619	625	626

#### Finishes *stainless steel*

US Number	US32D*
BHMA	630

#### Finishes *aluminum*

US Number	US28
BHMA	628

\* Available with Antimicrobial Coating, use suffix AM

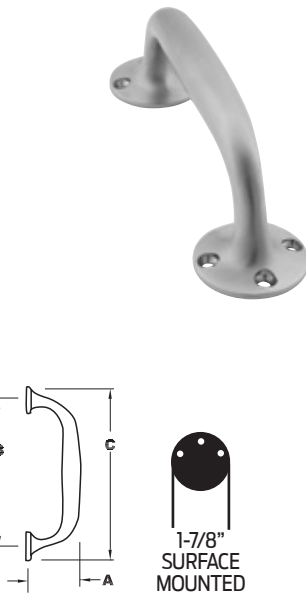

### 8112-5 Door Pull

Standard sheet metal screws for surface mounting

#### Size

5-1/4"

Product No.	Projection "A"	Center to Center "B"	Overall Length "C"
8112-5	2-13/16"	5-5/8"	7-1/2"

#### Finishes *brass*

US Number	US26D*
BHMA	626

\* Available with Antimicrobial Coating, use suffix AM

Hinges & Pivots  
**A**

Pulls & Plates  
**B5**

Flush Bolts & Coordinators  
**C**

Latches, Catches & Bolts  
**D**

Stops  
**E**

Exterior Hardware  
**F**

Miscellaneous Hardware  
**G**



## 8121 Door Pull

Available mounting – K see page B16

### Size

5-3/4"

Product No.	Projection "A"	Center to Center "B"	Overall Length "C"
8121-5	3-1/2"	5-3/4"	8-3/4"

### Finishes brass

US Number US26D\*

BHMA 626

\* Available with Antimicrobial Coating, use suffix AM

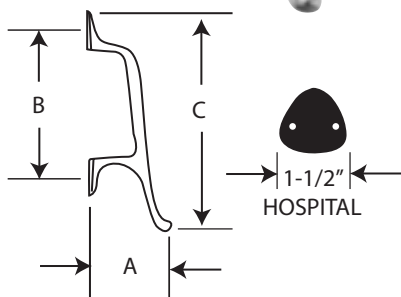

## 8190HD 90° Offset Door Pull

Available mounting – with heavy duty 3/8-16" mounting screws, standard H-I-L, N or O see page B15 and B17

### Available Sizes

8", 10", 12", 18"

Product No.	Projection "A"	Clearance	Center to Center "B"	Overall Length "C"
8190-8	3-1/4"	2-1/4"	8"	9"
8190-0	3-1/4"	2-1/4"	10"	11"
8190-2	3-1/4"	2-1/4"	12"	13"
8190-18	3-1/4"	2-1/4"	18"	19"

### Finishes brass

US Number US3 US4 US10 US10B US15 US26 US26D\*

BHMA 605 606 612 613 619 625 626

### Finishes stainless steel

US Number US32 US32D\*

BHMA 629 630

\* Available with Antimicrobial Coating, use suffix AM

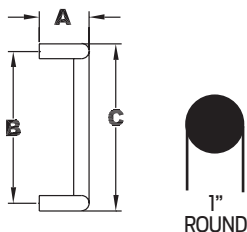

**A**  
Hinges & Pivots

**B6**  
Pulls & Plates

**C**  
Flush Bolts & Coordinators

**D**  
Latches, Catches & Bolts

**E**  
Stops

**F**  
Exterior Hardware

**G**  
Miscellaneous Hardware



**8200 Push Plate**  
**8300 Pull Plate, Prep for Pull (less pull)**

**Available Sizes**

- 3" x 12"
- 3.5" x 15"
- 4" x 16"
- 6" x 16"
- 8" x 16"

*Special sizes are available. Consult factory.*

**Plates Cut for Cylinder or Thumbturns**

Plates are available with cutout for cylinder or thumbturn; standard cutout is 2" from top and centered on plates up to 4" wide. For plates wider than 4" cutout is located 2" from outer edge, specify LH or RH. When pull location interferes with standard cutout location a detail drawing should be furnished with the order.

Standard cutout is 1-1/4" for cylinder and 3/8" for thumbturn.

Specify CFC for cutout for cylinder or CFT for cutout for thumbturn.

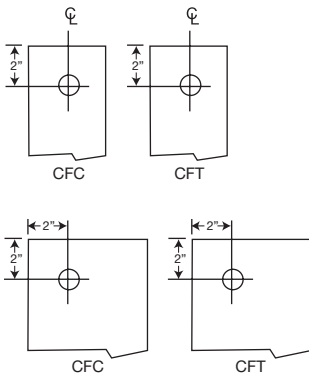

**Finishes brass**

US Number	US3	US4	US10	US10B	US15	US26	US26D*
BHMA	605	606	612	613	619	625	626

**Finishes stainless steel**

US Number	US32D*
BHMA	630

**Finishes aluminum**

US Number	US28
BHMA	628

*\* Available with Antimicrobial Coating, use suffix AM*

A  
Hinges & Pivots

B7  
Pulls & Plates

C  
Flush Bolts & Coordinators

D  
Latches, Catches & Bolts

E  
Stops

F  
Exterior Hardware

G  
Miscellaneous Hardware

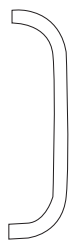

### 8302 Pull plate

Available mounting – Standard, F, G, H-I-L, or J see pages B15 and B16  
Pulls have new heavy duty 5/16-18" mounting.

<b>8300 Plate</b>	<b>8102 Pull</b>
3-1/2" x 15"	6" centers
4" x 16"	8" centers
6" x 16"	10" centers

#### Finishes brass

US Number	US3	US4	US10	US10B	US26	US26D*
BHMA	605	606	612	613	625	626

#### Finishes stainless steel

US Number	US32D*
BHMA	630

#### Finishes aluminum

US Number	US28
BHMA	628

\* Available with Antimicrobial Coating, use suffix AM

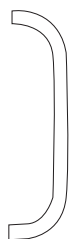

### 8303 Pull plate

Available mounting – Standard, F, G, H-I-L, or J see pages B15 and B16  
Pulls have new heavy duty 3/8-16" mounting.

<b>8300 Plate</b>	<b>8103 Pull</b>
3-1/2" x 15"	8" centers
4" x 16"	10" centers
6" x 16"	7" centers

#### Finishes brass

US Number	US3	US4	US10	US10B	US26	US26D*
BHMA	605	606	612	613	625	626

#### Finishes stainless steel

US Number	US32D*
BHMA	630

#### Finishes aluminum

US Number	US28
BHMA	628

\* Available with Antimicrobial Coating, use suffix AM



### 8305 Pull plate

Available mounting – Standard or F see page B15  
Pulls have 1/4 - 20" mounting

<b>8300 Plate</b>	<b>8105 Pull</b>
3-1/2" x 15"	6" centers
4" x 16"	8" centers
6" x 16"	10" centers

#### Finishes brass

US Number	US3	US4	US10	US10B	US26	US26D
BHMA	605	606	612	613	625	626

#### Finishes stainless steel

US Number	US32D
BHMA	630

#### Finishes aluminum

US Number	US28
BHMA	628

\* Available with Antimicrobial Coating, use suffix AM

**A**  
Hinges & Pivots

**B8**  
Pulls & Plates

**C**  
Flush Bolts & Coordinators

**D**  
Latches, Catches & Bolts

**E**  
Stops

**F**  
Exterior Hardware

**G**  
Miscellaneous Hardware



### 8311 Pull plate

Available mounting – Standard or F see page B15  
Pulls have 1/4-20" mounting.

**8300 Plate**  
3-1/2" x 15"  
4" x 16"  
6" x 16"

**8111-5 Pull**  
5-1/8" centers

#### Finishes brass

US Number	US3	US4	US10	US10B	US26	US26D*
BHMA	605	606	612	613	625	626

#### Finishes stainless steel

US Number	US32D*
BHMA	630

#### Finishes aluminum

US Number	US28
BHMA	628

\* Available with Antimicrobial Coating, use suffix AM

### 9100 Series Push Bar and Pull Combinations

- Available in brass, stainless steel or aluminum.
- Standard fasteners furnished for 1-3/4" thick doors. Specify door thick if other than standard.
- Special lengths are available, contact customer service.

See page B17 for special mounting requirements.

Caution – the length of the pushbar should not interfere with the door jamb or cause a pinch point.

### 9100HD Push Bar

Available mounting – NO or NS see page B17  
with heavy duty 3/8-16" mounting



Product No.	Projection	Clearance	Center to Center	Overall Length
9100-28	2-1/2"	1-1/2"	28"	29"
9100-33	2-1/2"	1-1/2"	33"	34"

Special lengths available, consult factory

#### Finishes brass

US Number	US3	US4	US10	US10B	US15	US26	US26D*
BHMA	605	606	612	613	619	625	626

#### Finishes stainless steel

US Number	US32	US32D*
BHMA	629	630

\* Available with Antimicrobial Coating, use suffix AM



A  
Hinges & Pivots

B9  
Pulls & Plates

C  
Flush Bolts & Coordinators

D  
Latches, Catches & Bolts

E  
Stops

F  
Exterior Hardware

G  
Miscellaneous Hardware

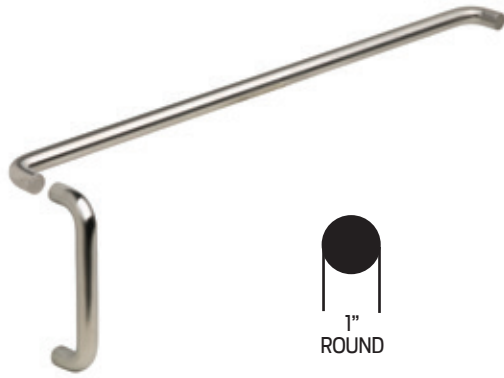

**9103EZHD Straight Pull/Pushbar Combo**  
(8103EZHD Pull + 9100HD Push)

Available mounting – NO or NS see page B17  
with heavy duty 3/8-16" mounting

Product No.	CTC Push	CTC Pull	Projection Push & Pull
9103EZ	28", 33"	8"	2-1/2" & 3-1/2"
9103EZ	28", 33"	10"	2-1/2" & 3-1/2"
9103EZ	28", 33"	12"	2-1/2" & 3-1/2"

Special lengths available, consult factory

**Finishes brass**

US Number	US3	US4	US10	US10B	US15	US26	US26D*
BHMA	605	606	612	613	619	625	626

**Finishes stainless steel**

US Number	US32	US32D*
BHMA	629	630

\* Available with Antimicrobial Coating, use suffix AM

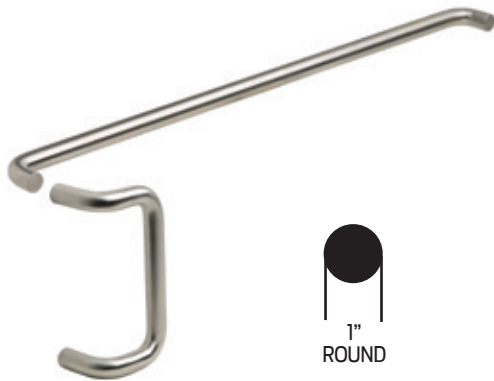

**9190HD Offset Pull/Pushbar Combo**  
(8190HD pull + 9100HD push)

Available mounting – NO or NS see page B17  
with heavy duty 3/8-16" mounting

Product No.	CTC Push	CTC Pull	Projection Push & Pull
9190	28", 33"	8"	2-1/2" & 3-1/4"
9190	28", 33"	10"	2-1/2" & 3-1/4"
9190	28", 33"	12"	2-1/2" & 3-1/4"
9190	28", 33"	18"	2-1/2" & 3-1/4"

Special lengths available, consult factory

**Finishes brass**

US Number	US3	US4	US10	US10B	US15	US26	US26D*
BHMA	605	606	612	613	619	625	626

**Finishes stainless steel**

US Number	US32	US32D*
BHMA	629	630

\* Available with Antimicrobial Coating, use suffix AM



## Long Door Pulls

Offered in two Models:

**9264**

**Offset**

**9266**

**Straight**

- Heavy 1-1/4" Round Brass or Stainless Steel
- Round or Flat Tip
- 316 Stainless Steel
- 1-3/4", 2" or 2-1/4" Door Thickness
- Round Tip Standard
- Flat Tip Optional

### Dimensions

Length: 36" / 20" CC

72" / 56" CC

Diameter: 1-1/4"

Projection: 2-3/4"

### Special Lengths Available

18" and 24"

Custom lengths available from 36" to 144"

### Finishes

Ives Number	US3	US4	US10B	US32	US32D
BHMA	605	606	613	629	630



Offset  
Bracket



Round Tip



Flat Tip

**Note:** A middle position bracket is required for pulls over 8 feet.

**Vandal Resistant Trim**

All stainless steel, 11 gauge (0.120" thick), using stainless steel fasteners for door thickness of 1-3/4" to 2-1/4". Built-in lock protector prevents tampering on certain models. Protective cylinder collar spins to reduce damage from pipe wrench or other tools. Models are available with or without attractive black plastisol edge grip.

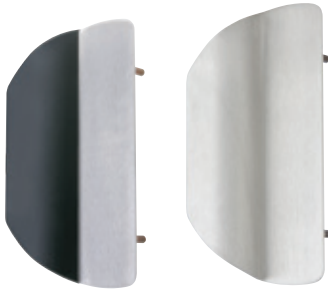

VR810

VR814

**VR810-DT With black grip**  
**VR814-DT Without black grip**

- For use with Falcon XX or 25 Series Exit Device
- Non-handed
- Thru-bolts direct to the exit device
- Pull operation only

Prod. No.	Width	Height	Thru-Bolt Pattern	Clearance Grip to Door	Projection
VR810DT	5-1/4"	11"	1-3/4" wide x 7-3/4" high	1-1/2"	1-7/8"

**Finishes**

US Finish	US32D
BHMA	630

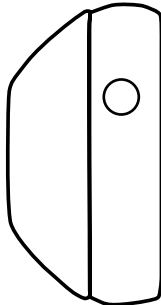

**VR810-NL LHR With black grip**  
**VR810-NL RHR With black grip**  
**VR814-NL LHR Without black grip**  
**VR814-NL RHR Without black grip**

- For use with Falcon XX-V
- Thru-bolts direct to the exit device
- Night latch operation (cylinder not furnished)

Prod. No.	Width	Height	Thru-Bolt Pattern	Clearance Grip to Door	Projection
VR810NL	5-1/4"	11"	1-3/4" wide x 7-3/4" high	1-1/2"	1-7/8"

**Finishes**

US Finish	US32D
BHMA	630

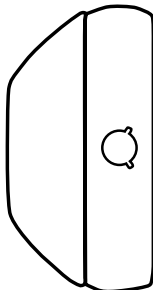

**VR810-NL-V With black grip**  
**VR814-NL-V Without black grip**

- For use with Falcon 25-R or 25-V Series exit devices
- Thru-bolts direct to the exit device
- Night latch operation (cylinder not furnished)

Prod. No.	Width	Height	Thru-Bolt Pattern	Clearance Grip to Door	Projection
VR810NL-V	5-1/4"	11"	1-3/4" wide x 7-3/4" high	1-1/2"	1-7/8"

**Finishes**

US Finish	US32D
BHMA	630

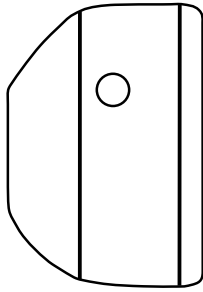

**VR900 RHR With black grip**  
**VR900 LHR With black grip**  
**VR904 RHR Without black grip**  
**VR904 LHR Without black grip**

- For use with most mortise locks on outswinging doors including
- Schlage L9000 Series with interior L or N escutcheon, and rose trim.
- Includes built-in lock protector and cylinder cutout.
- Handed design allows trim to be positioned to coordinate with the centerline of inside hardware.

Width	Height	Thru-Bolt Pattern	Clearance Grip to Door	Projection
7-1/4"	11"	2" wide x 10" high	1-1/2"	1-7/8"

**Finishes**

US Finish	US32D
BHMA	630

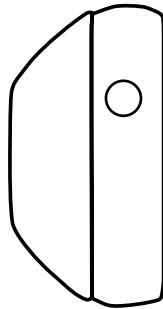

**VR900LLP RH With black grip**  
**VR900LLP LH With black grip**  
**VR904LLP RH Without black grip**  
**VR904LLP LH Without black grip**

- For use with most mortise locks on outswinging doors including
- Schlage L9000 Series with interior L or N escutcheon, and rose trim.
- Includes built-in lock protector and cylinder cutout.
- Handed design allows trim to be positioned to coordinate with the centerline of inside hardware.

Width	Height	Thru-Bolt Pattern	Clearance Grip to Door	Projection
5-1/4"	11"	1-3/4" wide x 10" high	1-1/2"	1-7/8"

**Finishes**

US Finish	US32D
BHMA	630

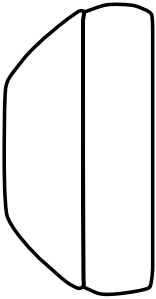

**VR910-DT With black grip**  
**VR914-DT Without black grip**

- For use with Von Duprin 98/99 Series rim and vertical rod exit device
- Non-handed
- Thru-bolts direct to the exit device
- Pull operation only.

Width	Height	Thru-Bolt Pattern	Clearance Grip to Door	Projection
5-1/4"	11"	1-3/8" wide x 7" high	1-1/2"	1-7/8"

**Finishes**

US Finish	US32D
BHMA	630

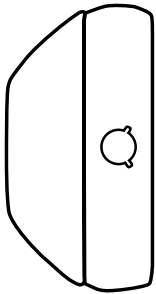

**VR910-NL With black grip**  
**VR914-NL Without black grip**

- For use with Von Duprin 98/99 rim and vertical rod exit device
- Non-handed
- Thru-bolts direct to the exit device

Width	Height	Thru-Bolt Pattern	Clearance Grip to Door	Projection
5-1/4"	11"	1-3/8" wide x 7" high	1-1/2"	1-7/8"

**Finishes**

US Finish	US32D
BHMA	630

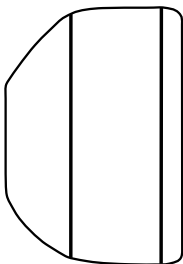

**VR910M-DT With black grip**  
**VR914M-DT Without black grip**

- For use with Von Duprin 9875/9975 mortise lock exit device
- Non-handed
- Thru-bolts direct to the exit device

Width	Height	Thru-Bolt Pattern	Clearance Grip to Door	Projection
7-1/4"	11"	1-3/8" wide x 7" high	1-1/2"	1-7/8"

**Finishes**

US Finish	US32D
BHMA	630

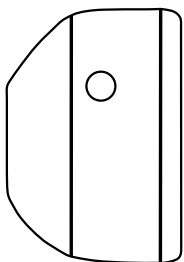

**VR910M-NL RHR With black grip**  
**VR910M-NL LHR With black grip**  
**VR914M-NL RHR Without black grip**  
**VR914M-NL LHR Without black grip**

- For use with Von Duprin 9875/9975 Series mortise lock exit device
- Thru-bolts direct to the exit device
- Night latch operation (cylinder not furnished)

Width	Height	Thru-Bolt Pattern	Clearance Grip to Door	Projection
7-1/4"	11"	1-3/8" wide x 7" high	1-1/2"	1-7/8"

**Finishes**

US Finish	US32D
BHMA	630

Hinges & Pivots

A

Pulls & Plates

B13

Flush Bolts & Coordinators

C

Latches, Catches & Bolts

D

Stops

E

Exterior Hardware

F

Miscellaneous Hardware

G

### 8400 Series Protection Plates

- Door protection plates are available in .050" thick brass, stainless steel or aluminum; and 1/8" thick high impact polyethylene in clear or black.
- Bevel edge options; specify B4E for all four edges.
- Mounting screw pack furnished standard, 16 screws per pack. Optional screw packs are available for TEK or TORK screw heads. Refer to the following chart for ordering.
- Specify NMH for no mounting holes. (Not available on 8402)
- Specify NMH-A for no mounting holes with adhesive. (Not available on 8402)
- Specify CS for counter sunk mounting holes.
- Specify ERS prepped with extra row of screws.

**Kickplate Gasket Tape** Tape is recommended when using a brass plate on a metal door to reduce tarnishing from electrolytic oxidation. One tape pack will cover an the perimeters of a 8" x 34" kickplate. Order 8401 Gasket Tape.



### 8400 Protection Plate 8402 (UL)\* Protection Plate

\*UL mark appears in upper right corner. Factory supplied screws must be used.

Number of screw packs required by plate size (specify TEK Screws or TORK screws).

	22"-25"	26"-33"	34"-41"	42"-48"
4"-8"	1	1	1	1
9"-16"	1	1	1	1
17"-24"	1	1	1	2
25"-32"	1	1	2	2
33"-40"	1	2	2	2
41"-48"	2	2	2	2

#### Finishes brass 24" x 48" max. size

US Number	US3	US4	US10	US10B	US15	US26	US26D
BHMA	605	606	612	613	619	625	626

#### Finishes stainless steel

US Number	US32	US32D
BHMA	629	630

#### Finishes aluminum

US Number	US28
BHMA	628

#### Finishes plastic

Clear and Black
-----------------

Residential Grade Kickplates available Carded only, finishes PA28, PA3, PA619, PA716, B3, B505, B619, B716

A  
Hinges & Pivots

B14  
Pulls & Plates

C  
Flush Bolts & Coordinators

D  
Latches, Catches & Bolts

E  
Stops

F  
Exterior Hardware

G  
Miscellaneous Hardware

## Mounting

- All mounting hardware is for standard 1-3/4" door.
- Consult Customer Service if other than standard.

### Type Standard Mount

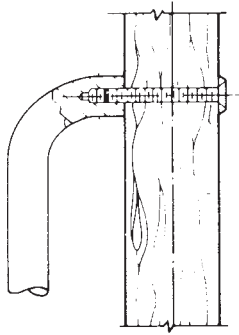

#### Standard Mounting

- (2) 3/8-16 x 2-1/4" brass, flat head machine screws; plate to match.
  - (2) 3/8-16 countersunk washers; plated to match
- Note: 8102HD and 8105 have (2) 5/16-18 x 2-1/2" machine screws  
 -Options: (2) 5/16 countersunk washers

### Type G Mount

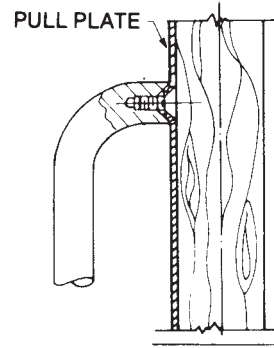

#### Concealed Pull Plate Mounting

- Available only for 8302, 8303, 8311 Pull Plates.
- (2) 3/8-16 x 5/8" steel flat head machine screws; zinc plated.
- Pull mounts directly onto plate.  
 Plate is attached to door by 6 screws.  
 Note: 8302 has (2) 5/16-19 x 5/8" steel flathead zinc plated screws

### Type F Mount

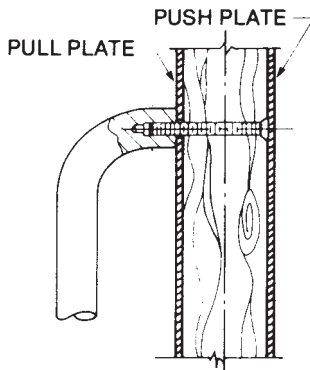

#### Wood Doors Concealed Pull Mounting With Push Plate

- (2) 2-1/4" steel flat head machine screws; zinc plated.
- Available only for 8102HD, 8103HD, 8105, 8111, 8302, 8303, 8305 and 8311. Plate on opposite side of door must be ordered separately.
- Note: 8102HD, 8302 will have 5/16-18  
 8105, 8111, 8305, 8311 will have 1/4-20  
 8103HD, 8303 will have 3/8-16"

### Type H-I-L Mount

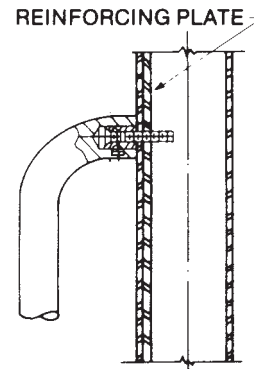

#### Reinforced Hollow Metal Door Concealed Pull Mounting

- Available only for 8102, 8103, 810EZ or wood door pulls, 8302, 8303 pull plates and 9264, 9265, 9266 and 9267 long door pulls.
- (2) Steel screw sleeves; zinc plated.
  - (2) Steel countersunk trim head machine screw; zinc plated for reinforced metal door.
  - (2) Steel countersunk trim head steel metal screw; zinc plated for wood doors.
- Note: 8102HD and 8302 will have 5/16-18"  
 8103HD, 8103EZHD, 8303 will have 3/8-16"

### Mounting

- All mounting hardware is for standard 1-3/4" door.
- Consult Customer Service if other than standard.

#### Type K Mount

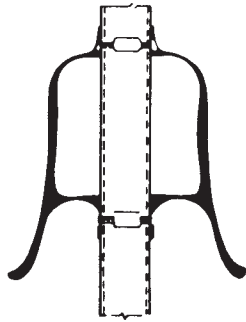

#### Back to Back Pull Mounting

Available only for 8121-5 Pulls.

- (4) Steel screw sleeve nuts; steel zinc plated.
  - (8) No. 8-32 x 1" brass oval head machine screws; plated to match.
- Pulls furnished in pairs (PR).



## Mounting for 8103EZ, 8190, 9100, 9103EZ, 9190 and 9264, 9265, 9266 and 9267 long door pulls.

• All mounting hardware is for standard 1-3/4" door.

• Consult Customer Service if other than standard.

### Type J/N Mount

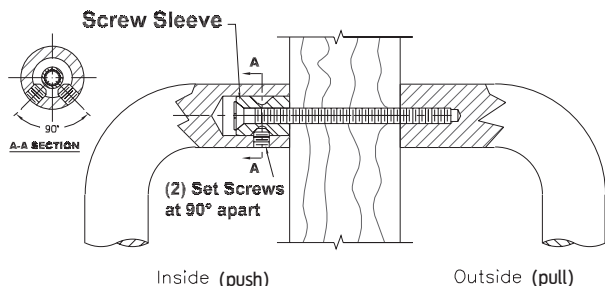

#### Back to Back "Two-Anchor"

Wood or Metal Door

Available only for 8103EZHD, 8190HD, 9100HD push/pull combinations and 9264, 9265, 9266 and 9267 long door pulls.

- (2) 3/8-16 x 2-3/4" steel countersunk trim head machine screws with (4) set screws for maximum anchoring force.
- (2) Steel screw sleeves; zinc plated.

### Type NS-Standard Push/Pull Mounting

Type N & Standard

Pushbar to Pull

- (1) 3/8 - 16 X 3" steel countersunk trim head machine screws with (2) set screws.
- (1) steel screw sleeve, zinc plated.

Free End Pushbar & Pull

- (2) 3/8 - 16 X 2-1/4" brass, oval head mach screws; plated to match.
- (2) No. 14 countersunk washers; plated to match.

### Type O Mount

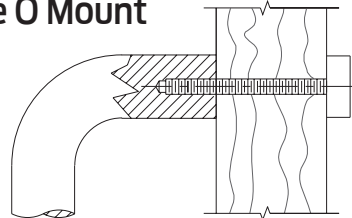

#### Decorative Blind Thru - Bolt

Wood or Metal Door

Available only for 8103EZHD, 8190HD and 9100HD Series Push/Pull Combinations.

- (2) 3/8-16 x 2-1/4" blind thru - bolts; plated to match.

### Type NO Push/Pull Mounting

Type N & Type O

Pushbar to Pull

- (1) 3/8 -16 X 3" steel countersunk trim head machine screws with (2) set screws.
- (1) steel screw sleeve, zinc plated.

Free End Pushbar & Pull

- (2) 3/8 - 16 X 2-1/4" blind thru-bolts; plated to match.

### Type P Mount

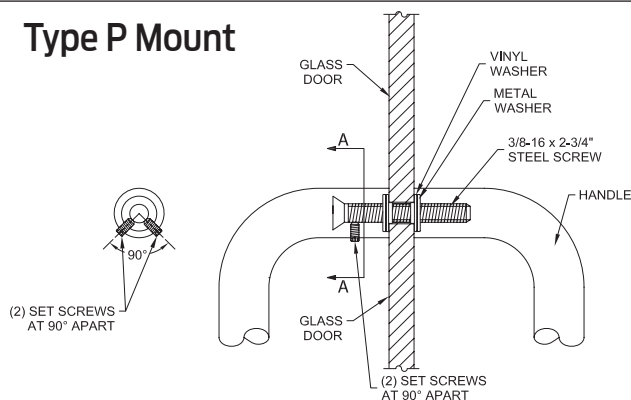

#### 1/2" Glass Door

Available only for 8103EZHD, 8190HD, 9100HD, 9265 and 9266 long door pulls.

- (2) 3/8-16 x 2-1/4" steel countersunk trim head machine screws with (4) set screws for maximum anchoring force.
- (2) Steel screw sleeves; zinc plated
- (2) Metal and Vinyl washers

Hinges & Pivots  
A

Pulls & Plates  
B17

Flush Bolts & Coordinators  
C

Latches, Catches & Bolts  
D

Stops  
E

Exterior Hardware  
F

Miscellaneous Hardware  
G

**A**

Hinges & Pivots

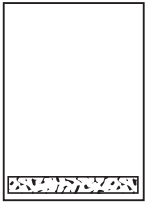

### Mop Plates

- Protect the bottom of the pull side of door subject to cleaning and mopping procedures.
- Size Ranges: 4" to 6" high, 22" to 48" wide

**B18**

Pulls & Plates



### Kick Plates

- Protect the bottom of the push side of doors subject to scuffing from foot traffic.
- Recommended for all doors subject to normal use (especially doors using a closer).
- Size Ranges: 8" to 24" high, 22" to 48" wide

**C**

Flush Bolts & Coordinators

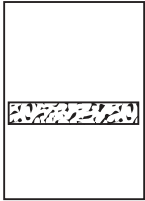

### Stretcher Plates

- Protect doors at specific areas where consistent contact is made by stretchers, service carts or other equipment.
- Usually applied to push side of doors.
- Specify "B4E" Option for beveled edges.
- Size Ranges: 6" to 8" high, 22" to 48" wide

**D**

Latches, Catches & Bolts

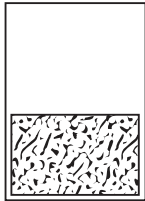

### Armor Plates

- Protect lower half of doors from abuse by hard carts, trucks and rough usage.
- Usually applied to push side of single doors and both sides of double acting doors.
- Size Ranges: 26" to 48" high, 22" to 48" wide

**E**

Stops

**F**

Exterior Hardware

**G**

Miscellaneous Hardware